



# Square PermaCast Columns

<b>Product</b>	<b>Table of Contents</b>	<b>SKU#</b>	<b>Page</b>
Plain			
6" x 6" x 6'		45988	3
6" x 6" x 8'		45990	4
6" x 6" x 9'		45991	5
6" x 6" x 10'		45992	6
8" x 8" x 6'		46008	7
8" x 8" x 8'		46010	8
8" x 8" x 9'		46011	9
8" x 8" x 10'		46012	10
8" x 8" x 12'		46014	11
10" x 10" x 8'		46030	12
10" x 10" x 9'		46031	13
10" x 10" x 10'		46032	14
10" x 10" x 12'		46034	15
10" x 10" x 14'		46036	16
10" x 10" x 16'		46038	17
12" x 12" x 8'		46050	18
12" x 12" x 9'		46051	19
12" x 12" x 10'		46052	20
12" x 12" x 12'		46054	21
12" x 12" x 14'		46056	22
12" x 12" x 16'		46058	23
12" x 12" x 18'		46060	24
16" x 16" x 8'		46090	25
16" x 16" x 10'		46092	26
16" x 16" x 12'		46094	27

For question about cut sheets or any of the HB&G Drawings please contact our Architectural department at 1-800-264-4HBG



It's a  
way of life...



# Square PermaCast Columns(continued)

## Table of Contents

<b>Product</b>	<b>SKU#</b>	<b>Page</b>
16"x 16"x 14'	46096	28
16"x 16"x 16'	46098	29
16"x 16"x 18'	46100	30
16"x 16"x 20'	46102	31
<b>Fluted</b>		
8"x 8"x 8'	46210	32
8"x 8"x 10'	46212	33
10"x 10"x 10'	46232	34
<b>Recessed Panel</b>		
8"x 8"x 8'	46382	35
8"x 8"x 9'	46384	36
8"x 8"x 10'	46386	37
10"x 10"x 8'	46402	38
10"x 10"x 9'	46404	39
10"x 10"x 10'	46406	40
12"x 12"x 8'	46422	41
12"x 12"x 9'	46424	42
12"x 12"x 10'	46426	43
14"x 14"x 10'	46446	44
<b>Craftsmen Column w/Cap &amp; Base</b>		
16"x 9"x 58"	46350	45
16"x 9"x 8"	46354	46
10"x 5.5"x 66"	46358	47
16"x 9"x 6'	46362	48

For question about cut sheets or any of the HB&G Drawings please contact our Architectural department at 1-800-264-4HBG

It's a  
way of life...

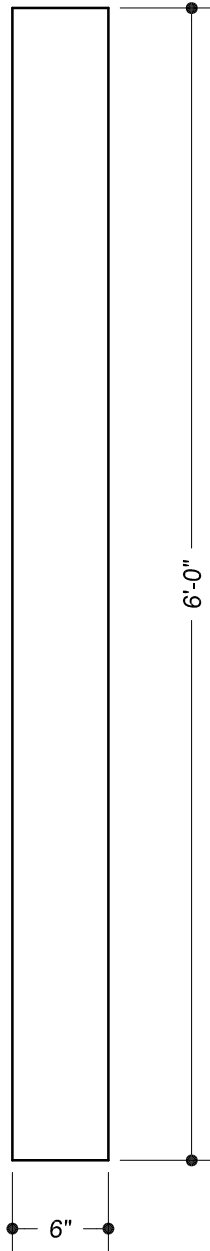

STOCK NUMBER: #45988

QUANTITY: -

PRODUCT MATERIAL: -

OTHER: -  
-

Approved by: \_\_\_\_\_

Date: \_\_\_\_\_

Drawn By: CAI, JLC  
Date: -  
Revised: -  
Scale: Not to Scale  
Checked by: -  
Sheet 1 of 1

Square PermaCast Column  
**6"x6"x6' Plain**



1015 Brundidge Blvd.  
P.O. Box 589  
Troy, Alabama 36081  
334.566.5000  
Fax 334.566.4626  
www.hbgcolumns.com

APPLIED NECK  
MOLDING

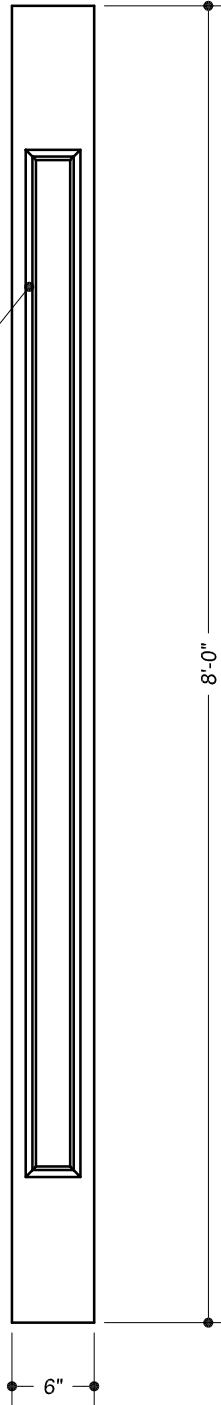

STOCK NUMBER: #45990

QUANTITY: -

PRODUCT MATERIAL: -

OTHER: -  
-

Approved by: \_\_\_\_\_

Date: \_\_\_\_\_

Drawn By: CAI, JLC  
Date: -  
Revised: -  
Scale: Not to Scale  
Checked by: -  
Sheet 1 of 1

Square PermaCast Column  
**6"x6"x8' Plain**



1015 Brundidge Blvd.  
P.O. Box 589  
Troy, Alabama 36081  
334.566.5000  
Fax 334.566.4626  
www.hbgcolumns.com

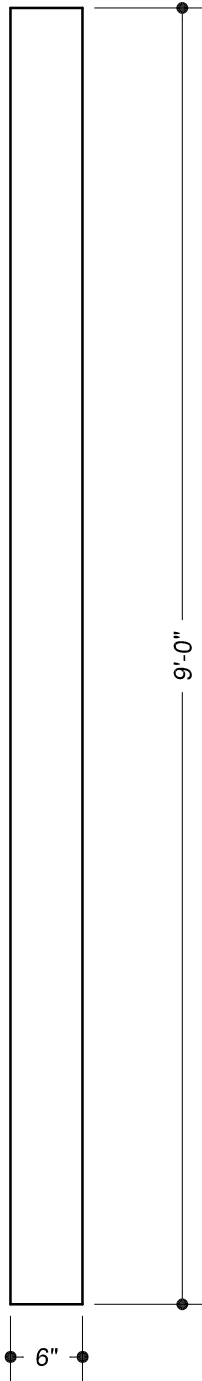

STOCK NUMBER: #45991

QUANTITY: -

PRODUCT MATERIAL: -

OTHER: -  
-

Approved by: \_\_\_\_\_

Date: \_\_\_\_\_

Drawn By: CAI, JLC  
Date: -  
Revised: -  
Scale: Not to Scale  
Checked by: -  
Sheet 1 of 1

Square PermaCast Column  
**6"x6"x9' Plain**



1015 Brundidge Blvd.  
P.O. Box 589  
Troy, Alabama 36081  
334.566.5000  
Fax 334.566.4626  
www.hbgcolumns.com

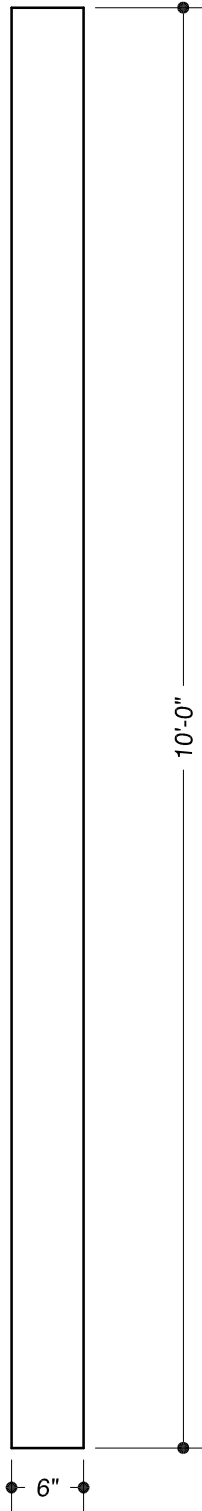

STOCK NUMBER: #45992

QUANTITY: -

PRODUCT MATERIAL: -

OTHER: -  
-

Approved by: \_\_\_\_\_

Date: \_\_\_\_\_

Drawn By: CAI, JLC  
Date: -  
Revised: .  
Scale: Not to Scale  
Checked by: .  
Sheet 1 of 1

Square PermaCast Column  
**6"x6"x10' Plain**



1015 Brundidge Blvd.  
P.O. Box 589  
Troy, Alabama 36081  
334.566.5000  
Fax 334.566.4626  
www.hbgcolumns.com

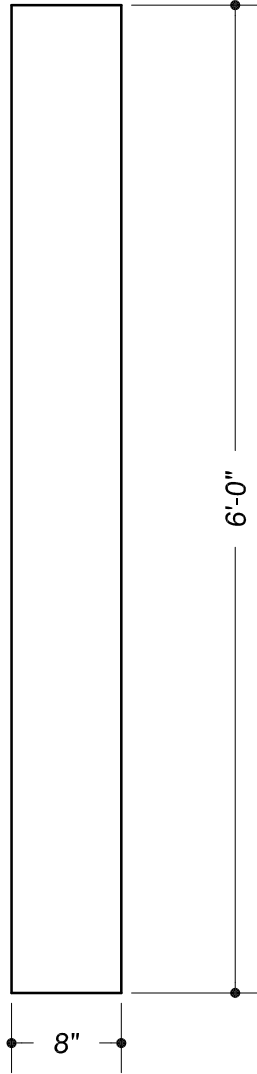

STOCK NUMBER: #46008

QUANTITY: -

PRODUCT MATERIAL: -

OTHER: -  
-

Approved by: \_\_\_\_\_ Date: \_\_\_\_\_

Drawn By: CAI, JLC  
Date: -  
Revised: .  
Scale: Not to Scale  
Checked by: .  
Sheet 1 of 1

Square PermaCast Column  
**8"x8"x6' Plain**



1015 Brundidge Blvd.  
P.O. Box 589  
Troy, Alabama 36081  
334.566.5000  
Fax 334.566.4626  
www.hbgcolumns.com

APPLIED MOLD  
(SOLD SEPARATELY)

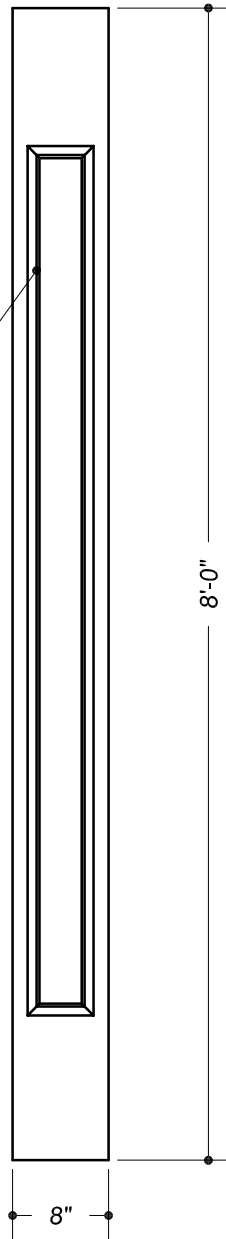

STOCK NUMBER: #46010

QUANTITY: -

PRODUCT MATERIAL: -

OTHER: -

-

Approved by: \_\_\_\_\_

Date: \_\_\_\_\_

Drawn By: CAI, JLC  
Date: -  
Revised: -  
Scale: Not to Scale  
Checked by: -  
Sheet 1 of 1

Square PermaCast Column  
**8"x8"x8' Plain**  
w/ Applied Molding (Sold Separately)

**H&G**  
Building Products

1015 Brundidge Blvd.  
P.O. Box 589  
Troy, Alabama 36081  
334.566.5000  
Fax 334.566.4626  
www.hbgcolumns.com



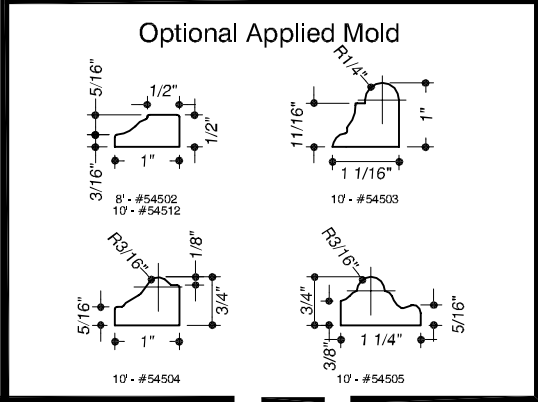
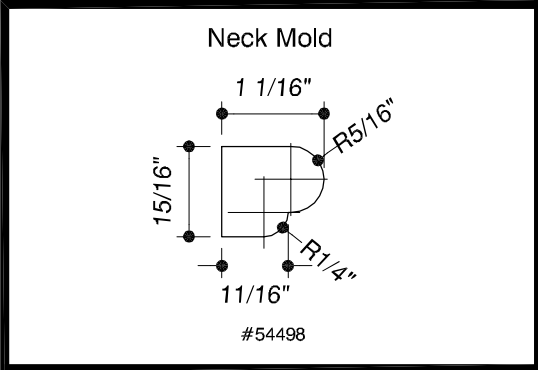
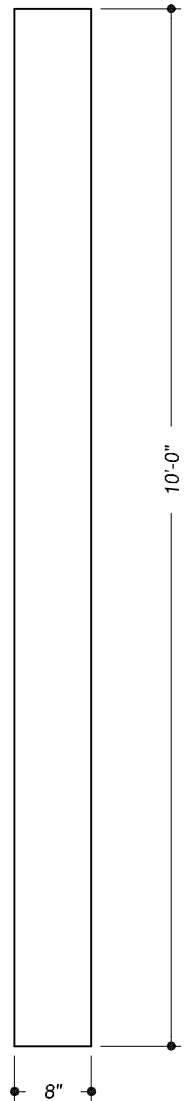

Approved by: \_\_\_\_\_ Date: \_\_\_\_\_

STOCK NUMBER: #46011

QUANTITY: -

PRODUCT MATERIAL: -

OTHER: -  
-

**Square PermaCast Column**  
**8"x8"x9' Plain**

Drawn By: CAI, JLC  
Date: -  
Revised: -  
Scale: Not to Scale  
Checked by: -  
Sheet 1 of 1

**H&G**  
Building Products

1015 Brundidge Blvd.  
P.O. Box 589  
Troy, Alabama 36081  
334.566.5000  
Fax 334.566.4626  
www.hbgcolumns.com

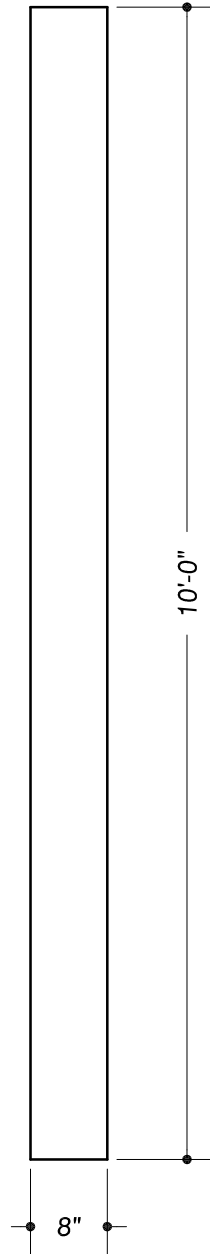

STOCK NUMBER: #46012

QUANTITY: -

PRODUCT MATERIAL: -

OTHER: -  
-

Approved by: \_\_\_\_\_

Date: \_\_\_\_\_

Drawn By: CAI, JLC  
Date: -  
Revised: -  
Scale: Not to Scale  
Checked by: -  
Sheet 1 of 1

Square PermaCast Column  
**8"x8"x10' Plain**



1015 Brundidge Blvd.  
P.O. Box 589  
Troy, Alabama 36081  
334.566.5000  
Fax 334.566.4626  
www.hbgcolumns.com

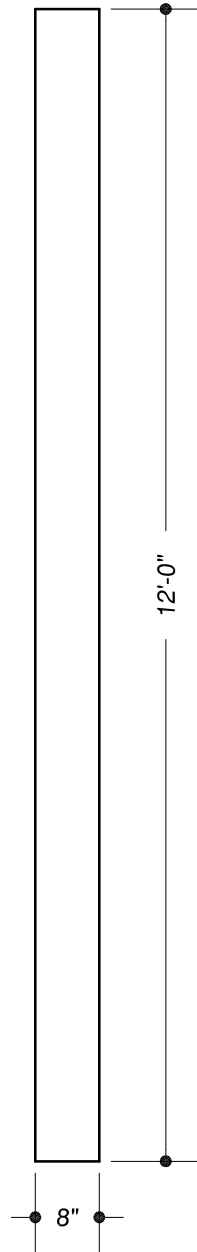

STOCK NUMBER: #46014

QUANTITY: -

PRODUCT MATERIAL: -

OTHER: -  
-

Approved by: \_\_\_\_\_

Date: \_\_\_\_\_

Drawn By: CAI, JLC  
Date: -  
Revised: -  
Scale: Not to Scale  
Checked by: -  
Sheet 1 of 1

Square PermaCast Column  
**8"x8"x12' Plain**



1015 Brundidge Blvd.  
P.O. Box 589  
Troy, Alabama 36081  
334.566.5000  
Fax 334.566.4626  
www.hbgcolumns.com

APPLIED MOLD  
(SOLD SEPARATELY)

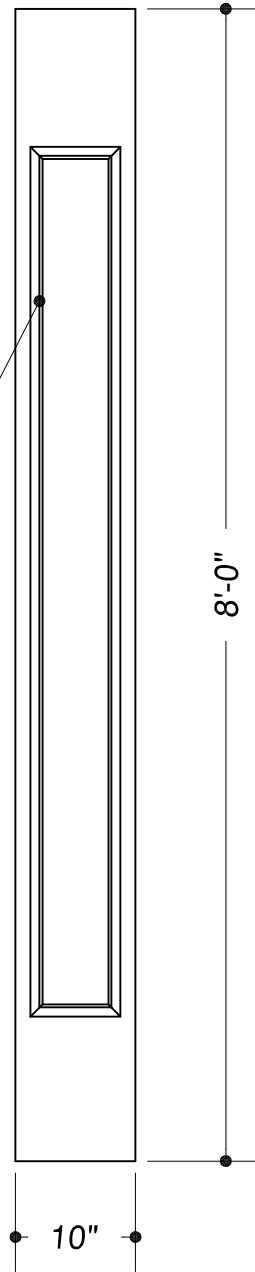

STOCK NUMBER: #46030

QUANTITY: -

PRODUCT MATERIAL: -

OTHER: -

Approved by: \_\_\_\_\_

Date: \_\_\_\_\_

Drawn By: CAI, JLC  
Date: -  
Revised: -  
Scale: Not to Scale  
Checked by: -  
Sheet 1 of 1

Square PermaCast Column  
**10"x10"x8' Plain**  
w/ Applied Molding (Sold Separately)



1015 Brundidge Blvd.  
P.O. Box 589  
Troy, Alabama 36081  
334.566.5000  
Fax 334.566.4626  
www.hbgcolumns.com

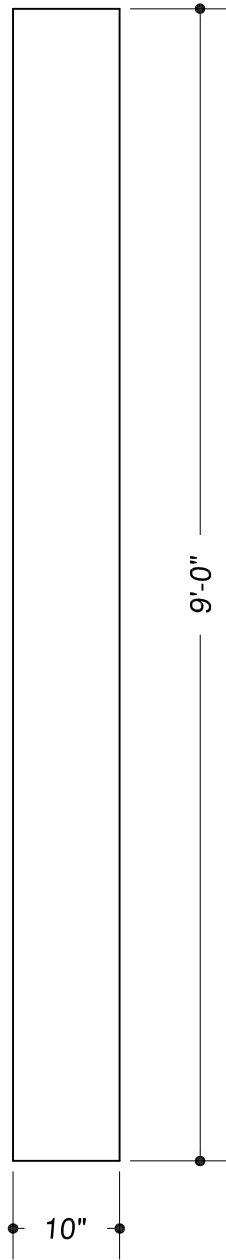

STOCK NUMBER: #46031

QUANTITY: -

PRODUCT MATERIAL: -

OTHER: -  
-

Approved by: \_\_\_\_\_

Date: \_\_\_\_\_

Drawn By: CAI, JLC  
Date: -  
Revised: -  
Scale: Not to Scale  
Checked by: -  
Sheet 1 of 1

Square PermaCast Column  
**10"x10"x9' Plain**



1015 Brundidge Blvd.  
P.O. Box 589  
Troy, Alabama 36081  
334.566.5000  
Fax 334.566.4626  
www.hbgcolumns.com

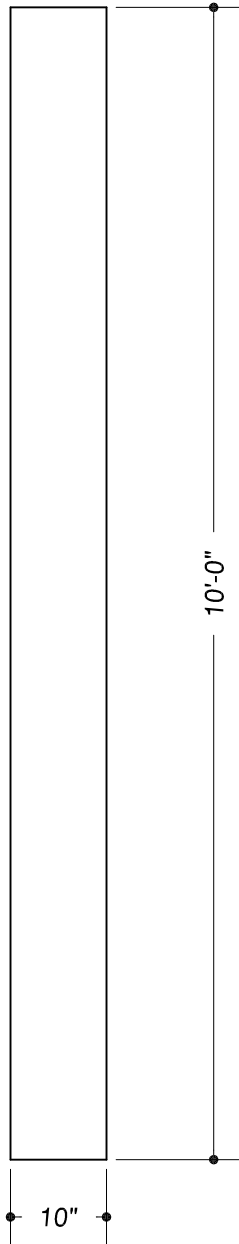

STOCK NUMBER: #46032

QUANTITY: -

PRODUCT MATERIAL: -

OTHER: -  
-

Approved by: \_\_\_\_\_

Date: \_\_\_\_\_

Drawn By: CAI, JLC  
Date: -  
Revised: -  
Scale: Not to Scale  
Checked by: -  
Sheet 1 of 1

Square PermaCast Column  
**10"x10"x10' Plain**

  
Building Products

1015 Brundidge Blvd.  
P.O. Box 589  
Troy, Alabama 36081  
334.566.5000  
Fax 334.566.4626  
www.hbgcolumns.com

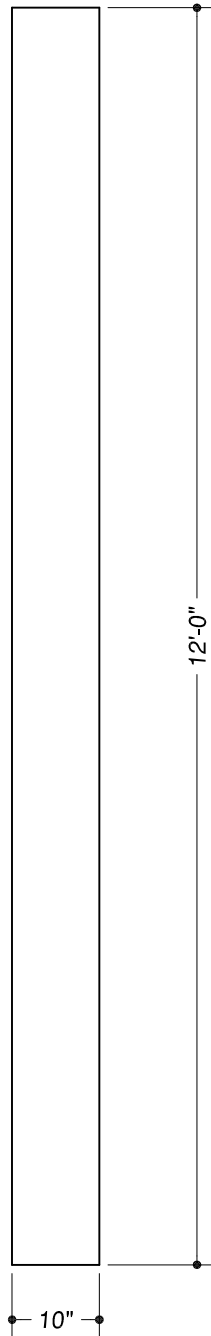

STOCK NUMBER: #46034

QUANTITY: -

PRODUCT MATERIAL: -

OTHER: -  
-

Approved by: \_\_\_\_\_

Date: \_\_\_\_\_

Drawn By: CAI, JLC  
Date: -  
Revised: -  
Scale: Not to Scale  
Checked by: -  
Sheet 1 of 1

Square PermaCast Column  
**10"x10"x12' Plain**



1015 Brundidge Blvd.  
P.O. Box 589  
Troy, Alabama 36081  
334.566.5000  
Fax 334.566.4626  
www.hbgcolumns.com

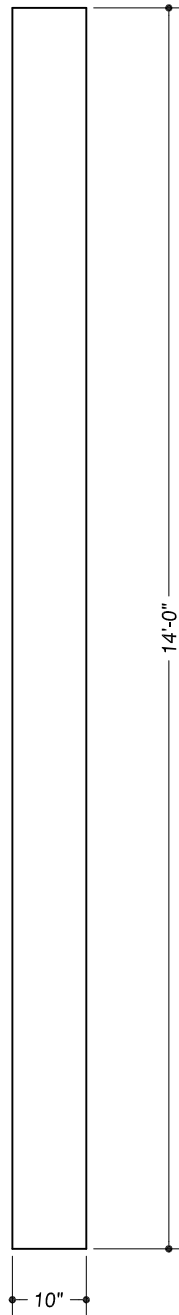

STOCK NUMBER: #46036

QUANTITY: -

PRODUCT MATERIAL: -

OTHER: -  
-

Approved by: \_\_\_\_\_

Date: \_\_\_\_\_

Drawn By: CAI, JLC  
Date: -  
Revised: -  
Scale: Not to Scale  
Checked by: -  
Sheet 1 of 1

Square PermaCast Column  
**10"x10"x14' Plain**



1015 Brundidge Blvd.  
P.O. Box 589  
Troy, Alabama 36081  
334.566.5000  
Fax 334.566.4626  
www.hbgcolumns.com



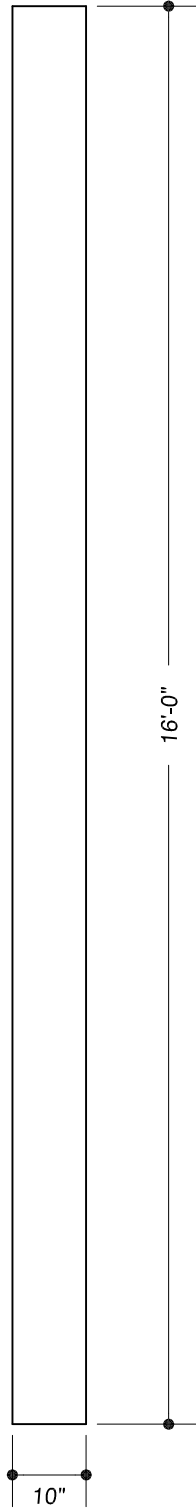

STOCK NUMBER: #46038

QUANTITY: -

PRODUCT MATERIAL: -

OTHER: -

Approved by: \_\_\_\_\_

Date: \_\_\_\_\_

Drawn By: CAI, JLC  
Date: -  
Revised: .  
Scale: Not to Scale  
Checked by: .  
Sheet 1 of 1

Square PermaCast Column  
**10"x10"x16' Plain**



1015 Brundidge Blvd.  
P.O. Box 589  
Troy, Alabama 36081  
334.566.5000  
Fax 334.566.4626  
www.hbgcolumns.com

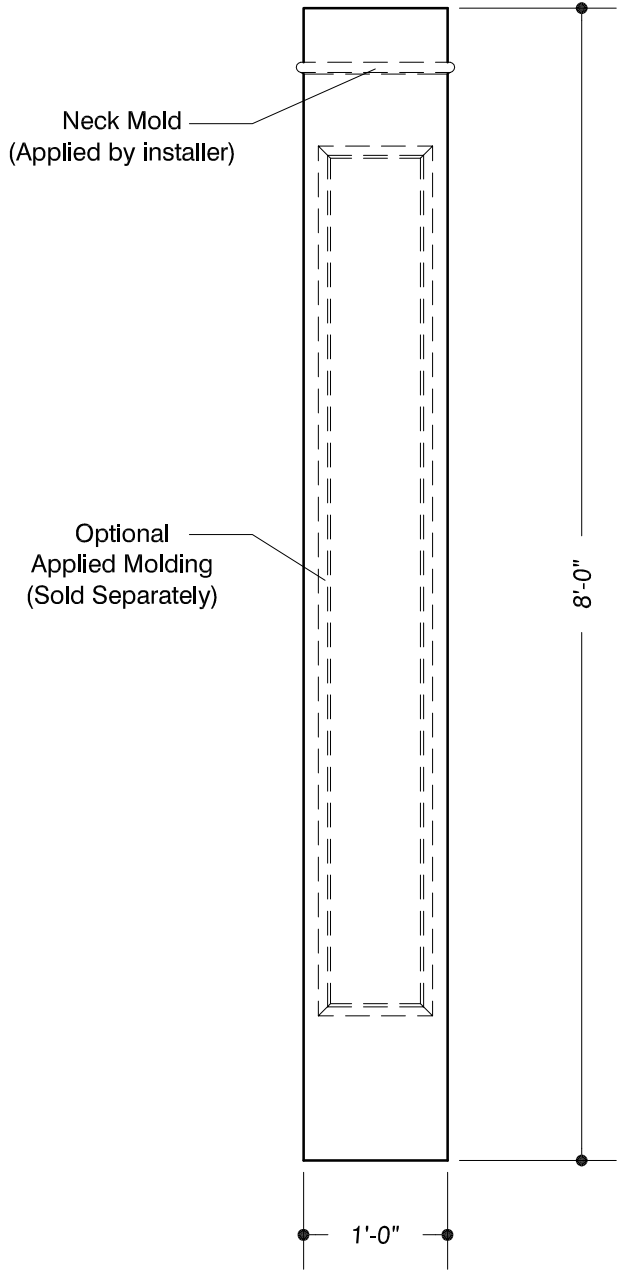

STOCK NUMBER: #46050

QUANTITY: -

PRODUCT MATERIAL: -

OTHER: -  
-

Approved by: \_\_\_\_\_

Date: \_\_\_\_\_

Drawn By: CAI, JLC  
Date: -  
Revised: -  
Scale: Not to Scale  
Checked by: -  
Sheet 1 of 1

Square PermaCast Column  
**12"x12"x8' Plain**  
w/ Applied Molding (Sold Separately)



1015 Brundidge Blvd.  
P.O. Box 589  
Troy, Alabama 36081  
334.566.5000  
Fax 334.566.4626  
www.hbgcolumns.com

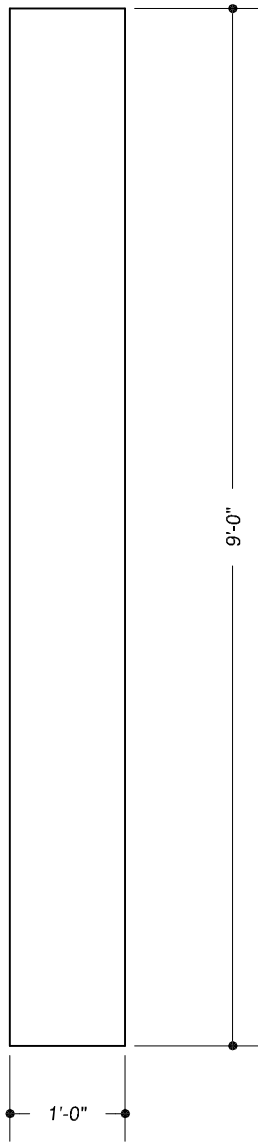

Approved by: \_\_\_\_\_ Date: \_\_\_\_\_

STOCK NUMBER: #46051

QUANTITY: -

PRODUCT MATERIAL: -

OTHER: -  
-

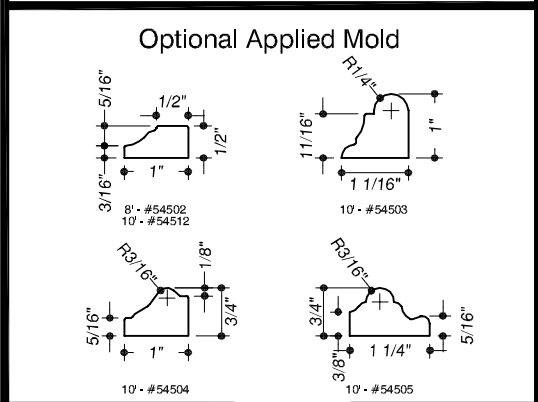
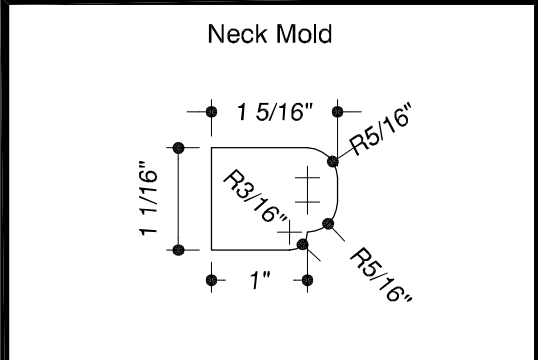

Drawn By: CAI, JLC  
Date: -  
Revised: -  
Scale: Not to Scale  
Checked by: -  
Sheet 1 of 1

**Square PermaCast Column**  
**12"x12"x9' Plain**



1015 Brundidge Blvd.  
P.O. Box 589  
Troy, Alabama 36081  
334.566.5000  
Fax 334.566.4626  
www.hbgcolumns.com

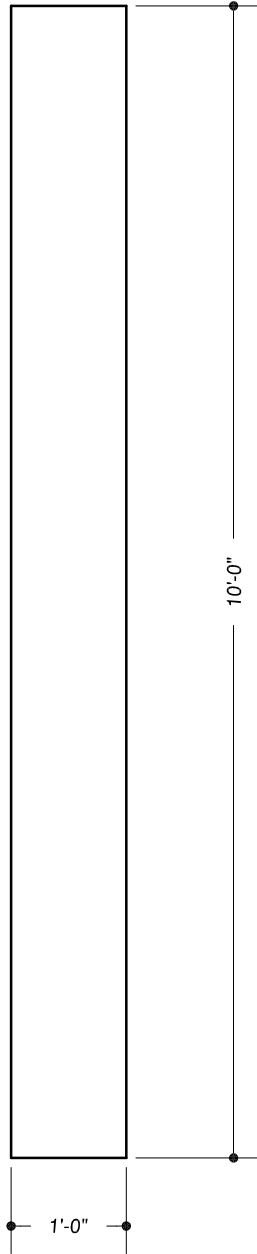

STOCK NUMBER: #46052

QUANTITY: -

PRODUCT MATERIAL: -

OTHER: -  
-

Approved by: \_\_\_\_\_

Date: \_\_\_\_\_

Drawn By: CAI, JLC  
Date: -  
Revised: -  
Scale: Not to Scale  
Checked by: -  
Sheet 1 of 1

Square PermaCast Column  
**12"x12"x10' Plain**



1015 Brundidge Blvd.  
P.O. Box 589  
Troy, Alabama 36081  
334.566.5000  
Fax 334.566.4626  
www.hbgcolumns.com

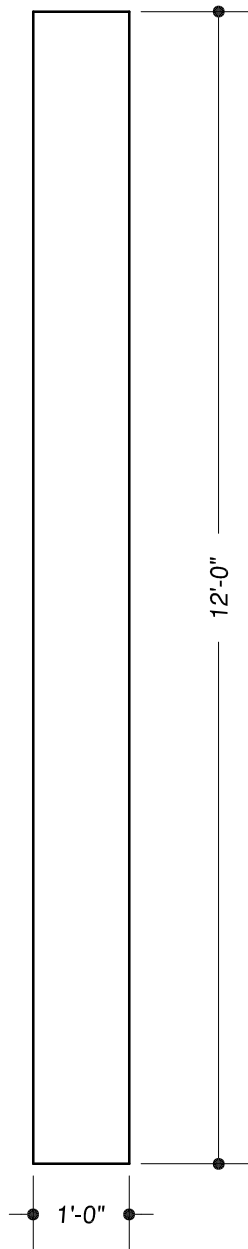

STOCK NUMBER: #46054

QUANTITY: -

PRODUCT MATERIAL: -

OTHER: -  
-

Approved by: \_\_\_\_\_

Date: \_\_\_\_\_

Drawn By: CAI, JLC  
Date: -  
Revised: -  
Scale: Not to Scale  
Checked by: -  
Sheet 1 of 1

Square PermaCast Column  
**12"x12"x12' Plain**



1015 Brundidge Blvd.  
P.O. Box 589  
Troy, Alabama 36081  
334.566.5000  
Fax 334.566.4626  
www.hbgcolumns.com

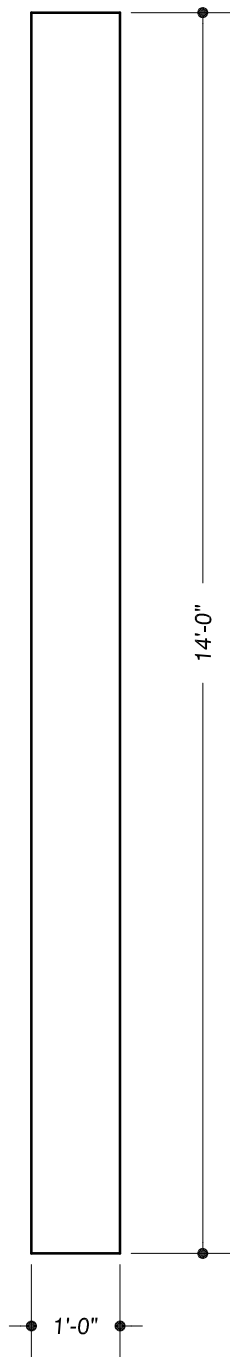

STOCK NUMBER: #46056

QUANTITY: -

PRODUCT MATERIAL: -

OTHER: -  
-

Approved by: \_\_\_\_\_

Date: \_\_\_\_\_

Drawn By: CAI, JLC  
Date: -  
Revised: -  
Scale: Not to Scale  
Checked by: -  
Sheet 1 of 1

Square PermaCast Column  
**12"x12"x14' Plain**



1015 Brundidge Blvd.  
P.O. Box 589  
Troy, Alabama 36081  
334.566.5000  
Fax 334.566.4626  
www.hbgcolumns.com

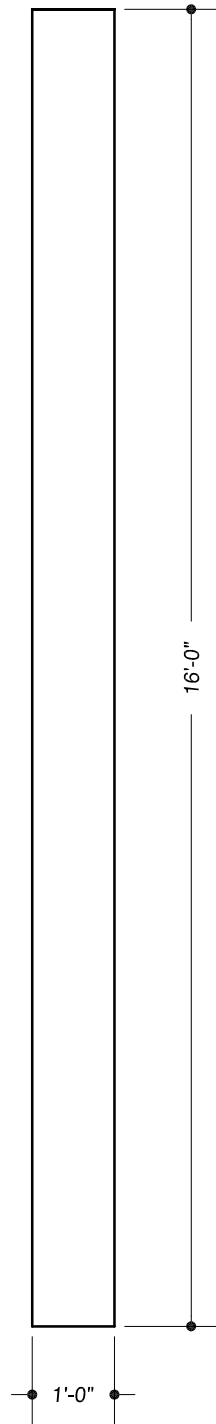

STOCK NUMBER: #46058

QUANTITY: -

PRODUCT MATERIAL: -

OTHER: -  
-

Approved by: \_\_\_\_\_

Date: \_\_\_\_\_

Drawn By: CAI, JLC  
Date: -  
Revised: -  
Scale: Not to Scale  
Checked by: -  
Sheet 1 of 1

Square PermaCast Column  
**12"x12"x16' Plain**



1015 Brundidge Blvd.  
P.O. Box 589  
Troy, Alabama 36081  
334.566.5000  
Fax 334.566.4626  
www.hbgcolumns.com

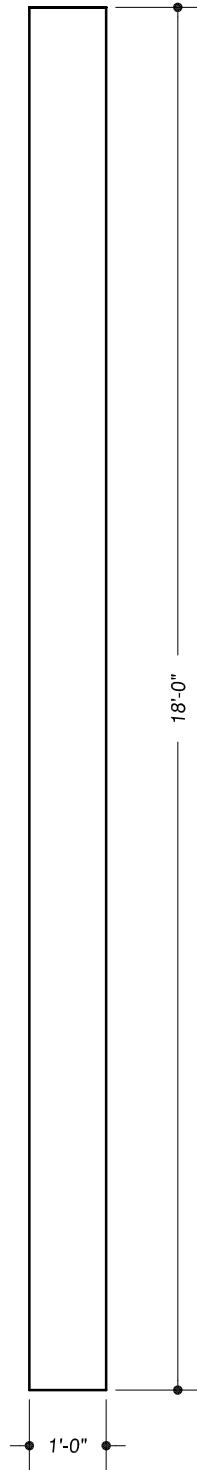

STOCK NUMBER: #46060

QUANTITY: -

PRODUCT MATERIAL: -

OTHER: -  
-

Approved by: \_\_\_\_\_

Date: \_\_\_\_\_

Drawn By: CAI, JLC  
Date: -  
Revised: -  
Scale: Not to Scale  
Checked by: -  
Sheet 1 of 1

Square PermaCast Column  
**12"x12"x18' Plain**



1015 Brundidge Blvd.  
P.O. Box 589  
Troy, Alabama 36081  
334.566.5000  
Fax 334.566.4626  
www.hbgcolumns.com



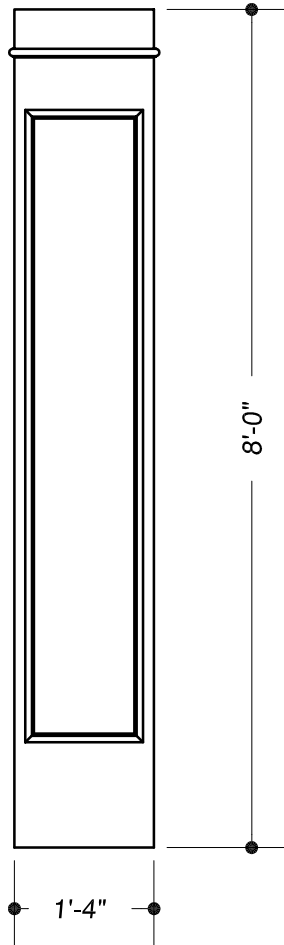

STOCK NUMBER: #46090

QUANTITY: -

PRODUCT MATERIAL: -

OTHER: -  
-

Approved by: \_\_\_\_\_

Date: \_\_\_\_\_

Drawn By: CAI, JLC  
 Date: -  
 Revised: -  
 Scale: Not to Scale  
 Checked by: -  
 Sheet 1 of 1

**Square PermaCast Column**  
**16"x16"x8' Plain**  
 w/ Applied Molding (Sold Separately)



1015 Brundidge Blvd.  
 P.O. Box 589  
 Troy, Alabama 36081  
 334.566.5000  
 Fax 334.566.4626  
 www.hbgcolumns.com

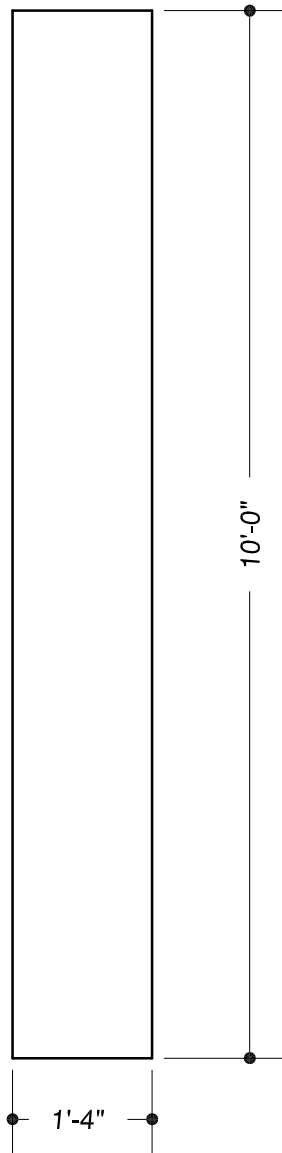

STOCK NUMBER: #46092

QUANTITY: -

PRODUCT MATERIAL: -

OTHER: -

Approved by: \_\_\_\_\_

Date: \_\_\_\_\_

Drawn By: CAI, JLC  
Date: -  
Revised: -  
Scale: Not to Scale  
Checked by: -  
Sheet 1 of 1

Square PermaCast Column  
**16"x16"x10' Plain**



1015 Brundidge Blvd.  
P.O. Box 589  
Troy, Alabama 36081  
334.566.5000  
Fax 334.566.4626  
www.hbgcolumns.com

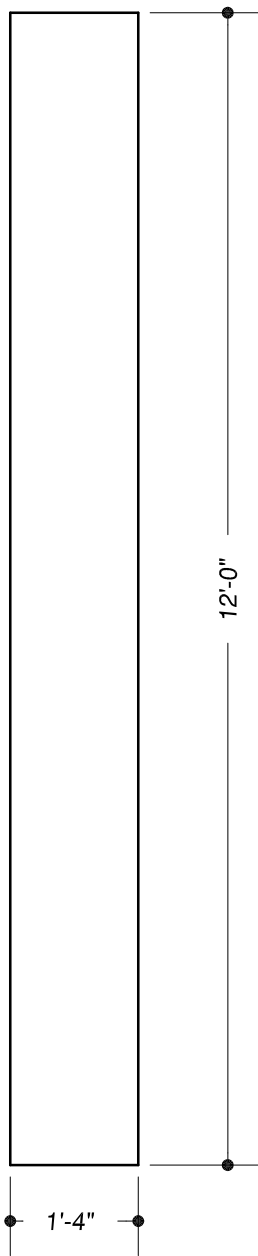

STOCK NUMBER: #46094

QUANTITY: -

PRODUCT MATERIAL: -

OTHER: -  
-

Approved by: \_\_\_\_\_ Date: \_\_\_\_\_

Drawn By: CAI, JLC  
Date: -  
Revised: -  
Scale: Not to Scale  
Checked by: -  
Sheet 1 of 1

Square PermaCast Column  
**16"x16"x12' Plain**



1015 Brundidge Blvd.  
P.O. Box 589  
Troy, Alabama 36081  
334.566.5000  
Fax 334.566.4626  
www.hbgcolumns.com

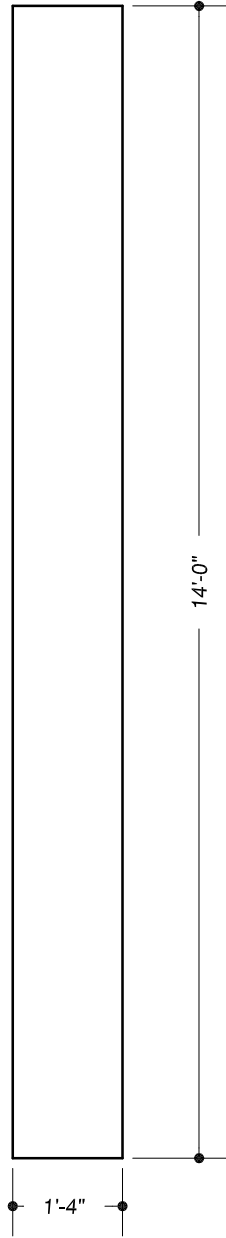

STOCK NUMBER: #46096

QUANTITY: -

PRODUCT MATERIAL: -

OTHER: -  
-

Approved by: \_\_\_\_\_

Date: \_\_\_\_\_

Drawn By: CAI, JLC  
Date: -  
Revised: -  
Scale: Not to Scale  
Checked by: -  
Sheet 1 of 1

Square PermaCast Column  
**16"x16"x14' Plain**



1015 Brundidge Blvd.  
P.O. Box 589  
Troy, Alabama 36081  
334.566.5000  
Fax 334.566.4626  
www.hbgcolumns.com

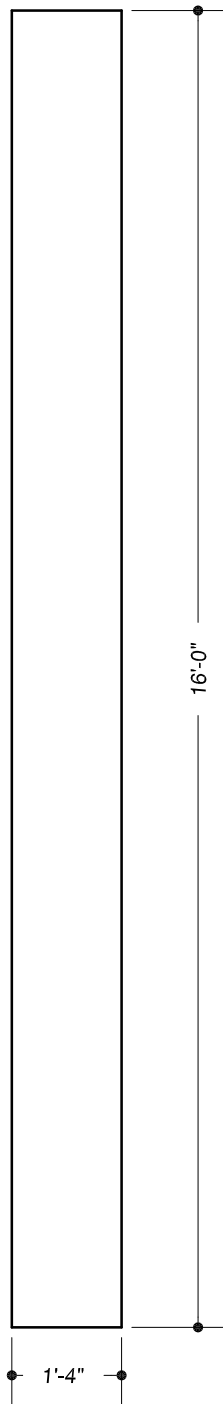

STOCK NUMBER: #46098

QUANTITY: -

PRODUCT MATERIAL: -

OTHER: -  
-

Approved by: \_\_\_\_\_ Date: \_\_\_\_\_

Drawn By: CAI, JLC  
Date: -  
Revised: -  
Scale: Not to Scale  
Checked by: -  
Sheet 1 of 1

**Square PermaCast Column**  
**16"x16"x16' Plain**



1015 Brundidge Blvd.  
P.O. Box 589  
Troy, Alabama 36081  
334.566.5000  
Fax 334.566.4626  
www.hbgcolumns.com

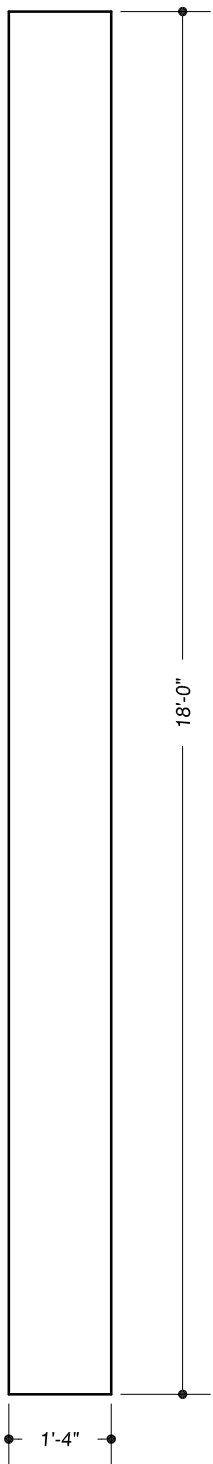

STOCK NUMBER: #46100

QUANTITY: -

PRODUCT MATERIAL: -

OTHER: -  
-

Approved by: \_\_\_\_\_

Date: \_\_\_\_\_

Drawn By: CAI, JLC  
Date: -  
Revised: -  
Scale: Not to Scale  
Checked by: -  
Sheet 1 of 1

Square PermaCast Column  
**16"x16"x18' Plain**



1015 Brundidge Blvd.  
P.O. Box 589  
Troy, Alabama 36081  
334.566.5000  
Fax 334.566.4626  
www.hbgcolumns.com

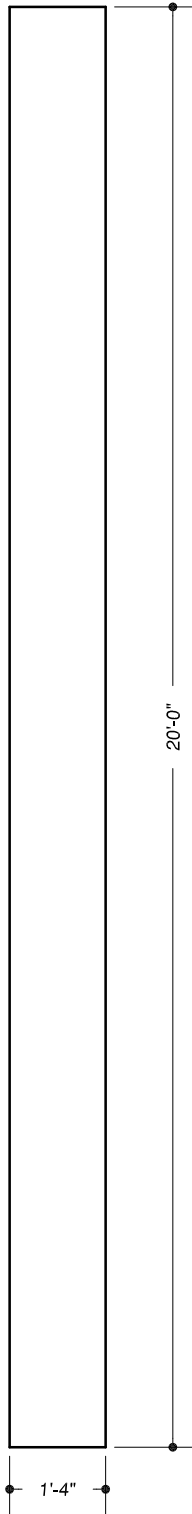

STOCK NUMBER: #46102

QUANTITY: -

PRODUCT MATERIAL: -

OTHER: -  
-

Approved by: \_\_\_\_\_

Date: \_\_\_\_\_

Drawn By: CAI, JLC  
Date: -  
Revised: -  
Scale: Not to Scale  
Checked by: -  
Sheet 1 of 1

Square PermaCast Column  
**16"x16"x20' Plain**



1015 Brundidge Blvd.  
P.O. Box 589  
Troy, Alabama 36081  
334.566.5000  
Fax 334.566.4626  
www.hbgcolumns.com

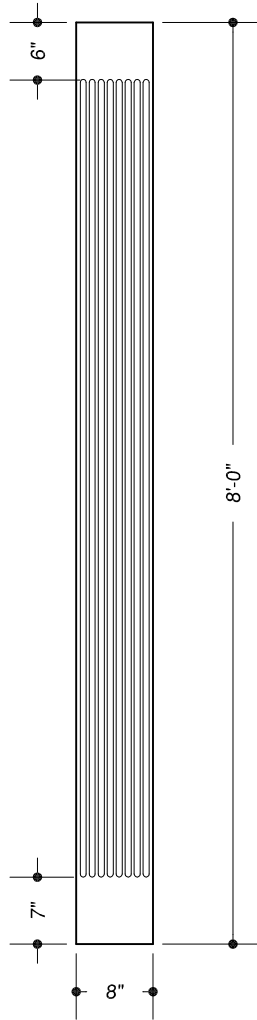
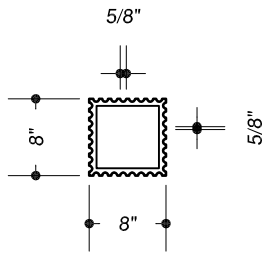

STOCK NUMBER: #46210

QUANTITY: -

PRODUCT MATERIAL: -

OTHER: -

Approved by: \_\_\_\_\_ Date: \_\_\_\_\_

Drawn By: CAI, JLC  
 Date: -  
 Revised: .  
 Scale: Not to Scale  
 Checked by: .  
 Sheet 1 of 1

Square PermaCast Column  
**8"x8"x8' Fluted**



1015 Brundidge Blvd.  
 P.O. Box 589  
 Troy, Alabama 36081  
 334.566.5000  
 Fax 334.566.4626  
 www.hbgcolumns.com



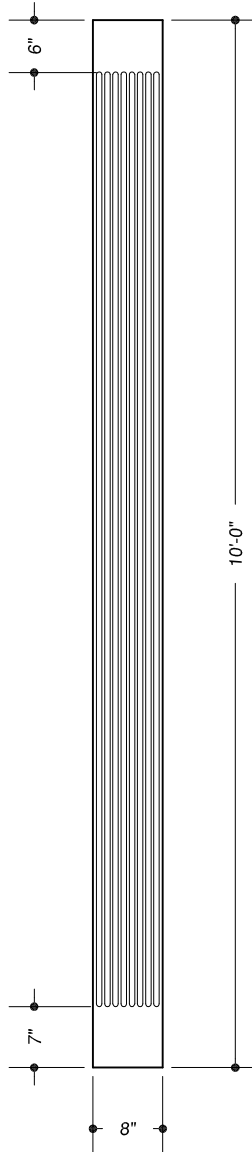
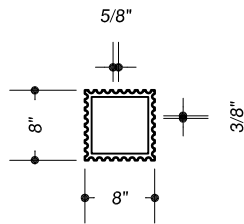

STOCK NUMBER: #46212

QUANTITY: -

PRODUCT MATERIAL: -

OTHER: -

Approved by: \_\_\_\_\_

Date: \_\_\_\_\_

Drawn By: CAI, JLC  
 Date: -  
 Revised: -  
 Scale: Not to Scale  
 Checked by: -  
 Sheet 1 of 1

Square PermaCast Column  
**8"x8"x10' Fluted**



1015 Brundidge Blvd.  
 P.O. Box 589  
 Troy, Alabama 36081  
 334.566.5000  
 Fax 334.566.4626  
 www.hbgcolumns.com

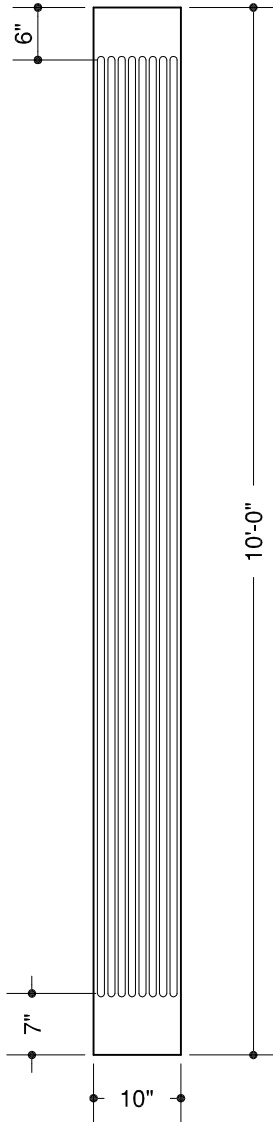
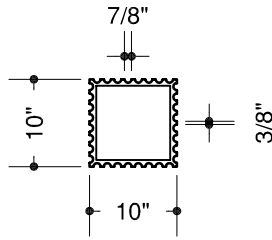

STOCK NUMBER: #46232

QUANTITY: -

PRODUCT MATERIAL: -

OTHER: -

Approved by: \_\_\_\_\_

Date: \_\_\_\_\_

Drawn By: CAI, JLC  
 Date: -  
 Revised: -  
 Scale: Not to Scale  
 Checked by: -  
 Sheet: 1 of 1

**Square PermaCast Column**  
**10"x10"x10' Fluted**



1015 Brundidge Blvd.  
 P.O. Box 589  
 Troy, Alabama 36081  
 334.566.5000  
 Fax 334.566.4626  
 www.hbgcolumns.com

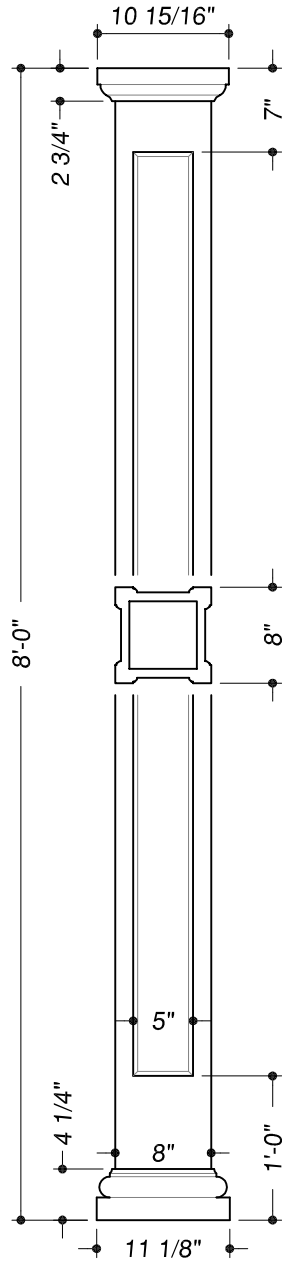

Approved by: \_\_\_\_\_ Date: \_\_\_\_\_

STOCK NUMBER: #46382

QUANTITY: -

PRODUCT MATERIAL: -

OTHER: Tuscan Cap & Base Set (#54301)

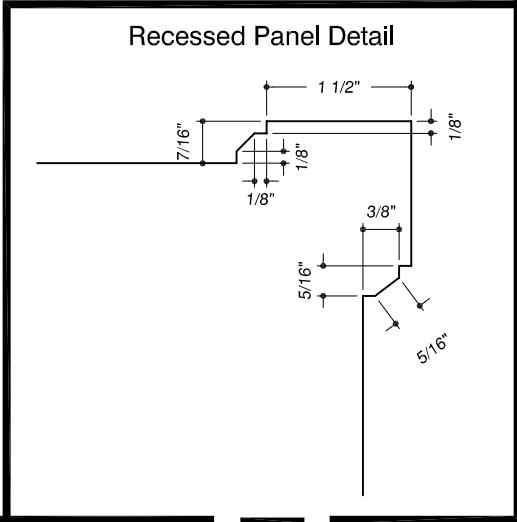

Drawn By: CAI, JLC  
 Date: -  
 Revised: -  
 Scale: Not to Scale  
 Checked by: -  
 Sheet 1 of 1

Recessed Panel Square PermaCast Column  
**8"x8"x8'**

**H&G**  
 Building Products

1015 Brundidge Blvd.  
 P.O. Box 589  
 Troy, Alabama 36081  
 334.566.5000  
 Fax 334.566.4626  
 www.hbgcolumns.com

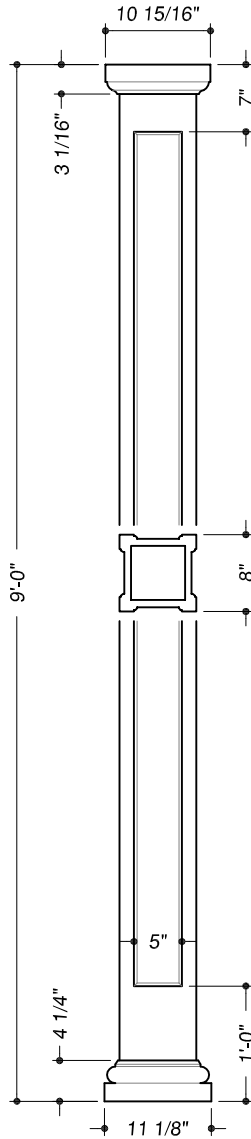

Approved by: \_\_\_\_\_ Date: \_\_\_\_\_

STOCK NUMBER: #46384

QUANTITY: -

PRODUCT MATERIAL: -

OTHER: Tuscan Cap & Base Set (#54301)

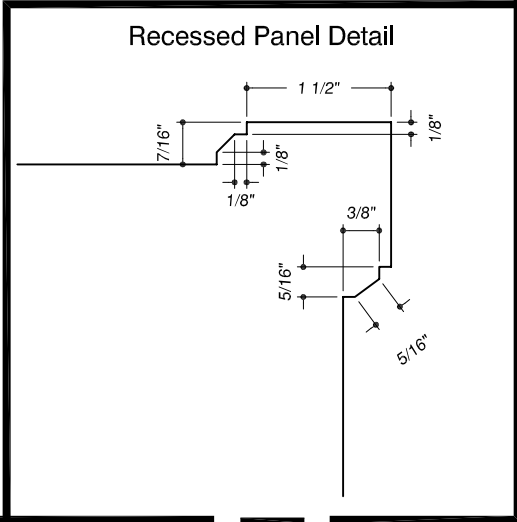

Recessed Panel Square PermaCast Column  
**8"x8"x9'**

Drawn By: CAI, JLC  
Date: -  
Revised: -  
Scale: Not to Scale  
Checked by: -  
Sheet 1 of 1



1015 Brundidge Blvd.  
P.O. Box 589  
Troy, Alabama 36081  
334.566.5000  
Fax 334.566.4626  
www.hbgcolumns.com

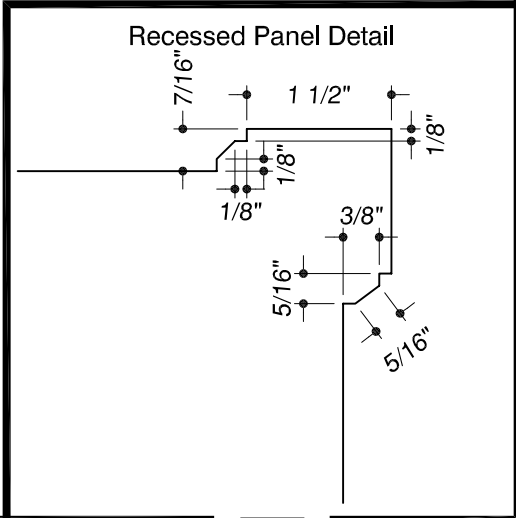
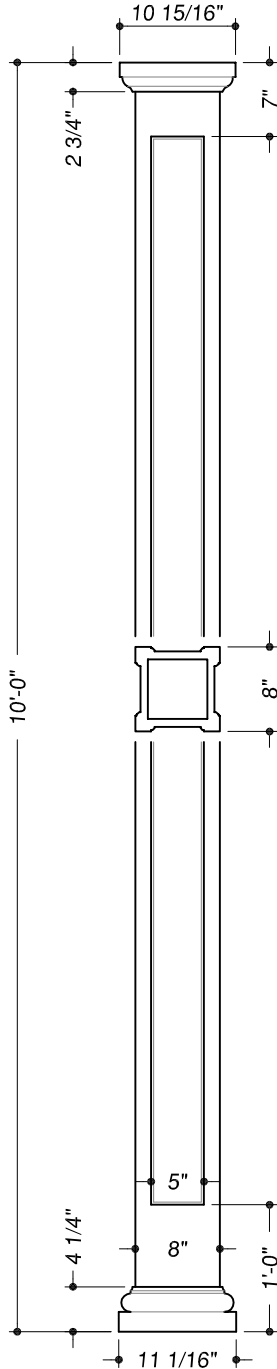

Approved by: \_\_\_\_\_ Date: \_\_\_\_\_

STOCK NUMBER: #46386  
 QUANTITY: -  
 PRODUCT MATERIAL: -  
 OTHER: Tuscan Cap & Base Set (#54301)

Recessed Panel Square PermaCast Column  
**8"x8"x10'**

Drawn By: CAI, JLC  
 Date: -  
 Revised: -  
 Scale: Not to Scale  
 Checked by: -  
 Sheet 1 of 1



1015 Brundidge Blvd.  
 P.O. Box 589  
 Troy, Alabama 36081  
 334.566.5000  
 Fax 334.566.4626  
 www.hbgcolumns.com

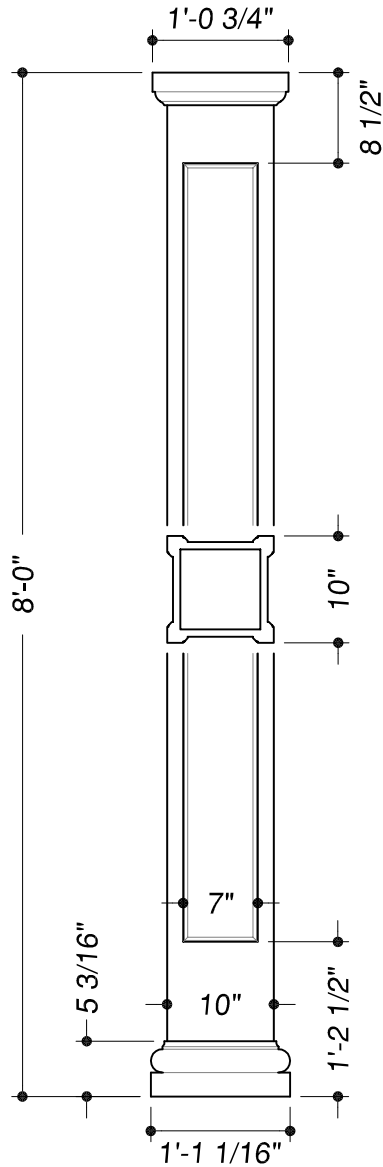

Approved by: \_\_\_\_\_ Date: \_\_\_\_\_

STOCK NUMBER: #46402

QUANTITY: -

PRODUCT MATERIAL: -

OTHER: w/ Tuscan Cap & Base Set (#54305)

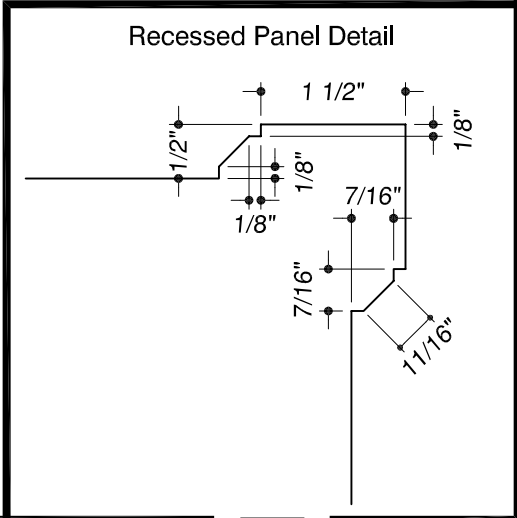

Drawn By: CAI, JLC  
 Date: -  
 Revised: -  
 Scale: Not to Scale  
 Checked by: -  
 Sheet 1 of 1

**Recessed Panel Square PermaCast Column**  
**10"x10"x8'**

**H&G**  
 Building Products

1015 Brundidge Blvd.  
 P.O. Box 589  
 Troy, Alabama 36081  
 334.566.5000  
 Fax 334.566.4626  
 www.hbgcolumns.com

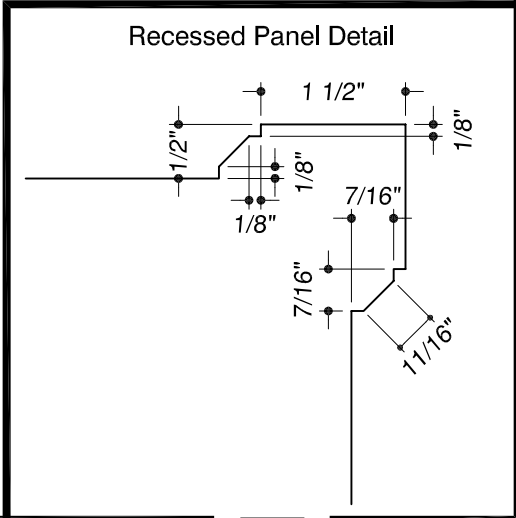
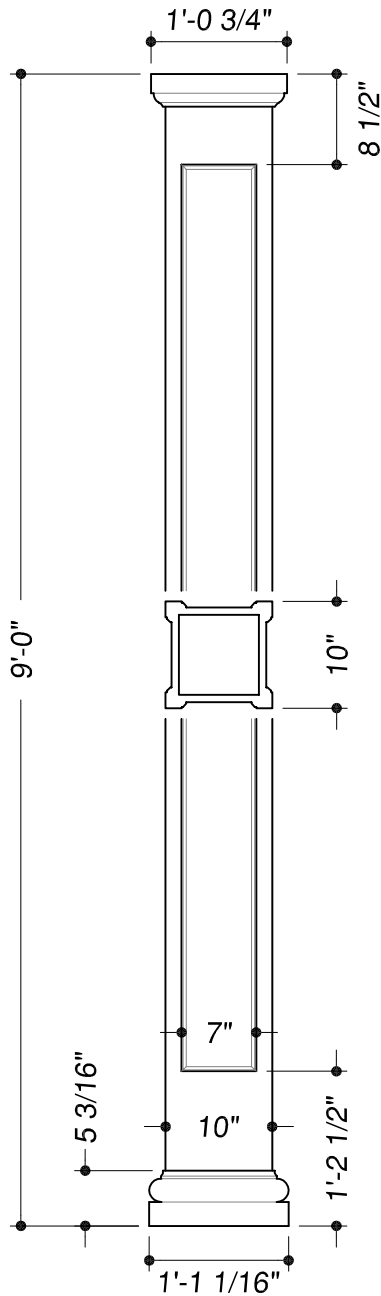

Approved by: \_\_\_\_\_ Date: \_\_\_\_\_

STOCK NUMBER: #46404

QUANTITY: -

PRODUCT MATERIAL: -

OTHER: Tuscan Cap & Base Set (#54305)

Drawn By: CAI, JLC  
 Date: -  
 Revised: -  
 Scale: Not to Scale  
 Checked by: -  
 Sheet: 1 of 1

**Recessed Panel Square PermaCast Column**  
**10"x10"x9'**



1015 Brundidge Blvd.  
 P.O. Box 589  
 Troy, Alabama 36081  
 334.566.5000  
 Fax 334.566.4626  
 www.hbgcolumns.com

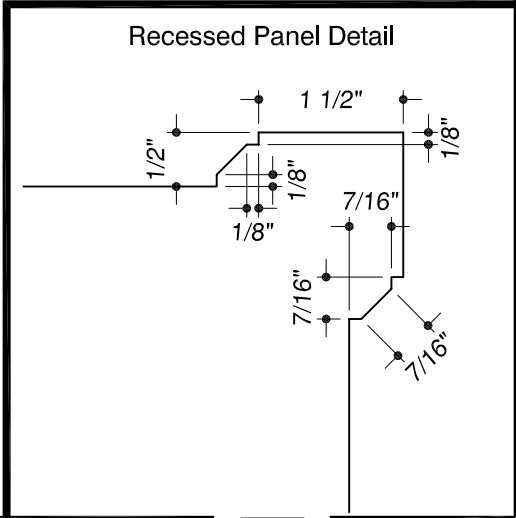
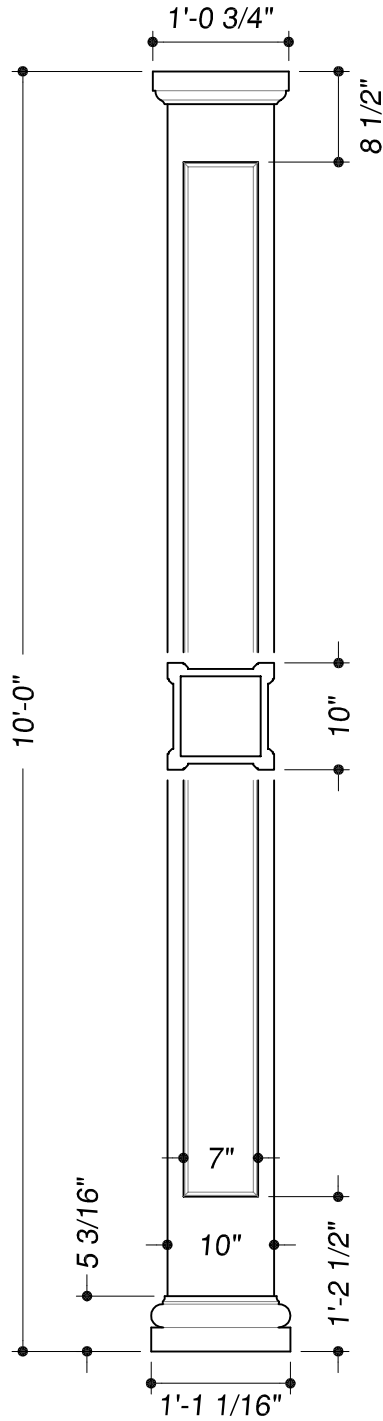

Approved by: \_\_\_\_\_ Date: \_\_\_\_\_

STOCK NUMBER: #46406

QUANTITY: -

PRODUCT MATERIAL: -

OTHER: w/ Tuscan Cap & Base Set (#54305)

Drawn By: CAI, JLC  
 Date: -  
 Revised: -  
 Scale: Not to Scale  
 Checked by: -  
 Sheet: 1 of 1

**Recessed Panel Square PermaCast Column**  
**10"x10"x10'**

**H&G**  
 Building Products

1015 Brundidge Blvd.  
 P.O. Box 589  
 Troy, Alabama 36081  
 334.566.5000  
 Fax 334.566.4626  
 www.hbgcolumns.com



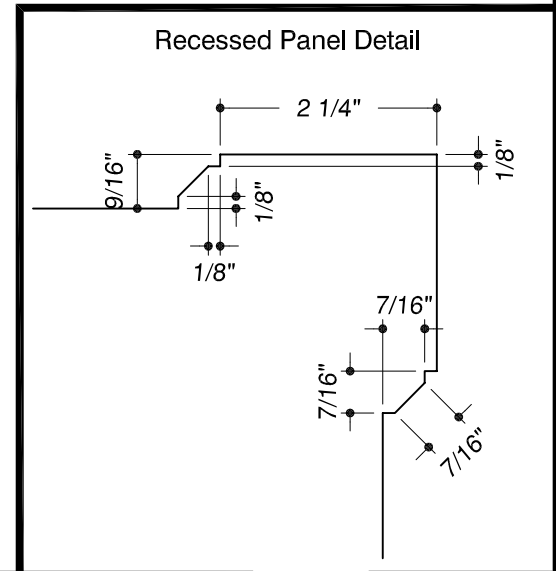
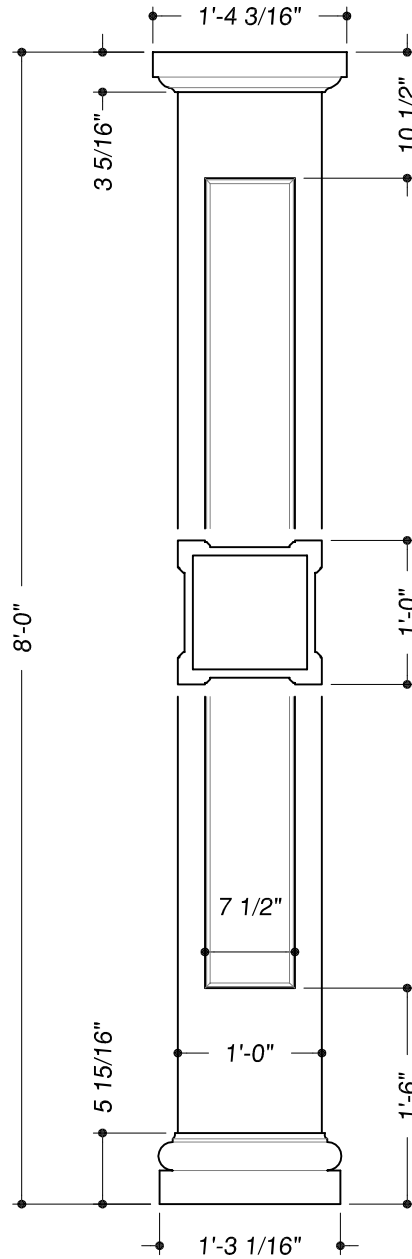

Approved by: \_\_\_\_\_ Date: \_\_\_\_\_

STOCK NUMBER: #46422  
 QUANTITY: -  
 PRODUCT MATERIAL: -  
 OTHER: w/ Tuscan Cap & Base Set (#54309)

Recessed Panel Square PermaCast Column  
**12"x12"x8'**

Drawn By: CAI, JLC  
 Date: -  
 Revised: -  
 Scale: Not to Scale  
 Checked by: -  
 Sheet 1 of 1

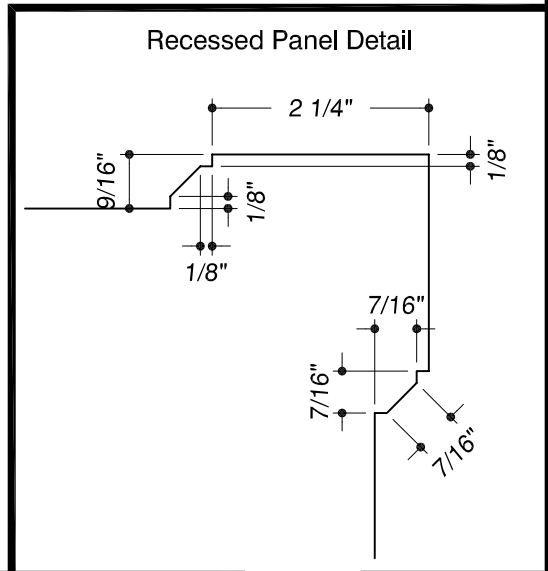
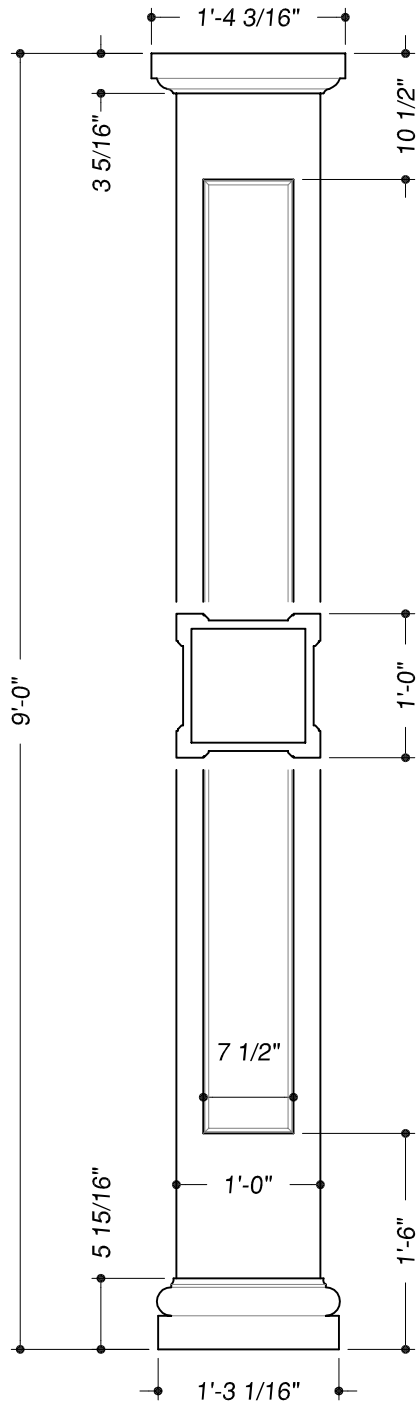

Approved by: \_\_\_\_\_ Date: \_\_\_\_\_

STOCK NUMBER: #46424

QUANTITY: -

PRODUCT MATERIAL: -

OTHER: w/ Tuscan Cap & Base Set (#54309)

Drawn By: CAI, JLC  
 Date: -  
 Revised: -  
 Scale: Not to Scale  
 Checked by: -  
 Sheet 1 of 1

Recessed Panel Square PermaCast Column  
**12"x12"x9'**

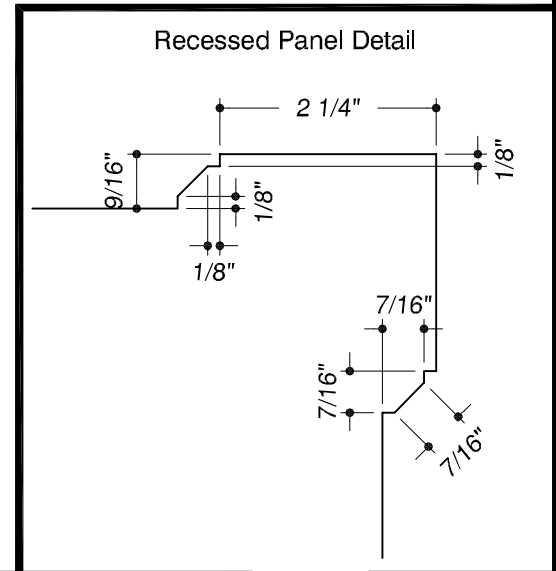
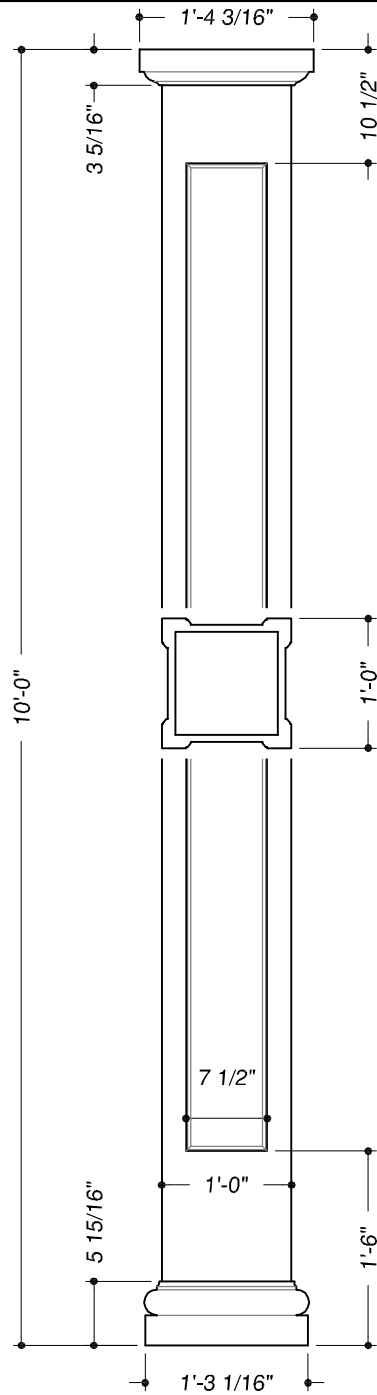

STOCK NUMBER: #46426  
 QUANTITY: -  
 PRODUCT MATERIAL: -  
 OTHER: w/ Tuscan Cap & Base Set (#54309)

Drawn By: CAI, JLC  
 Date: -  
 Revised: -  
 Scale: Not to Scale  
 Checked by: -  
 Sheet 1 of 1

Recessed Panel Square PermaCast Column  
**12"x12"x10'-0"**

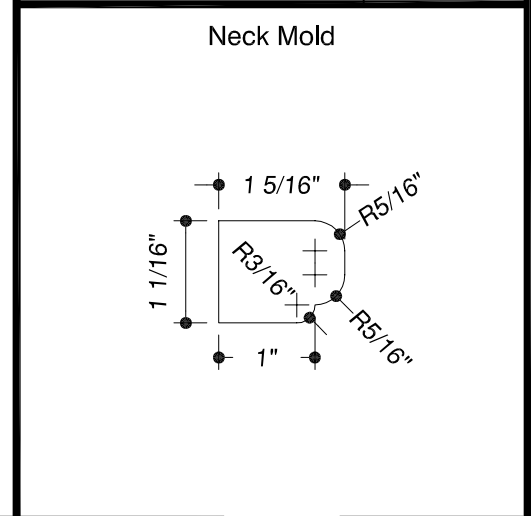
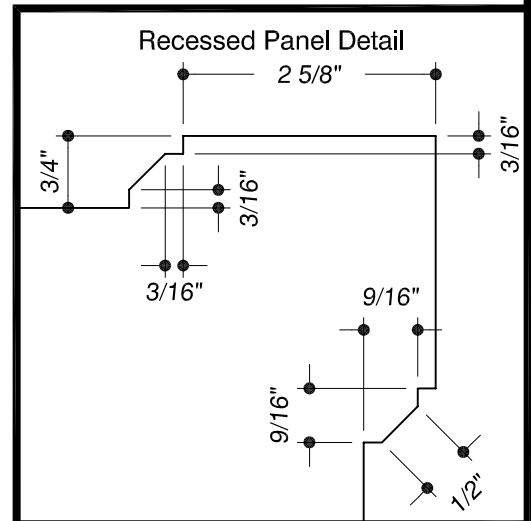
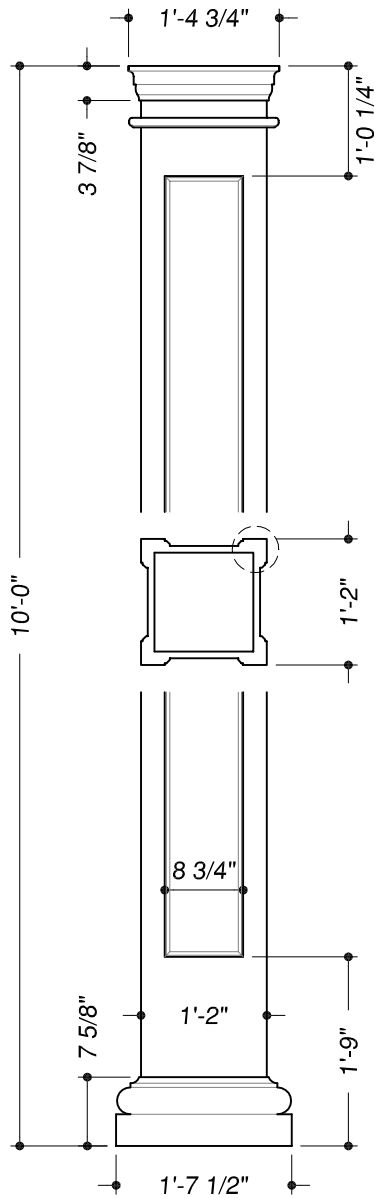

Approved by: \_\_\_\_\_ Date: \_\_\_\_\_

STOCK NUMBER: #46446

QUANTITY: -

PRODUCT MATERIAL: -

OTHER: Tuscan Cap & Base Set (#54313)

-

Drawn By: CAI, JLC  
 Date: -  
 Revised: -  
 Scale: Not to Scale  
 Checked by: -  
 Sheet 1 of 1

Square PermaCast Recessed Panel Column  
**14"x14"x10'**

**H&G**  
 Building Products

1015 Brundidge Blvd.  
 P.O. Box 589  
 Troy, Alabama 36081  
 334.566.5000  
 Fax 334.566.4626  
 www.hbgcolumns.com

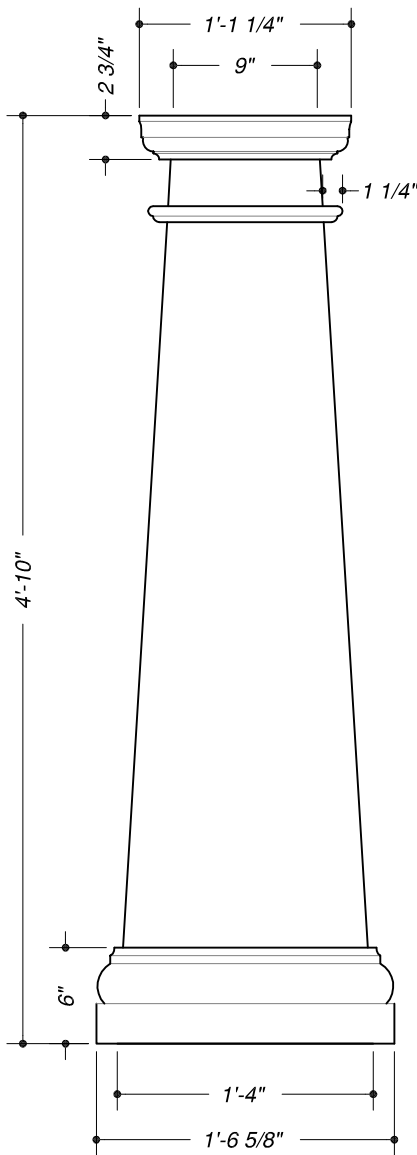

STOCK NUMBER: #46350

QUANTITY: -

PRODUCT MATERIAL: Fiber Reinforced Polymer

OTHER: Includes Tuscan Cap & Base (#46352-46353)  
Column Ships Unfinished & Unassembled

Approved by: \_\_\_\_\_

Date: \_\_\_\_\_

Drawn By: CAI, JLC  
Date: -  
Revised: -  
Scale: Not to Scale  
Checked by: -  
Sheet: 1 of 1

PermaCast Column  
**Craftsman Column**  
16"x9"x58" w/ Tuscan Cap & Base



1015 Brundidge Blvd.  
P.O. Box 589  
Troy, Alabama 36081  
334.566.5000  
Fax 334.566.4626  
www.hbgcolumns.com

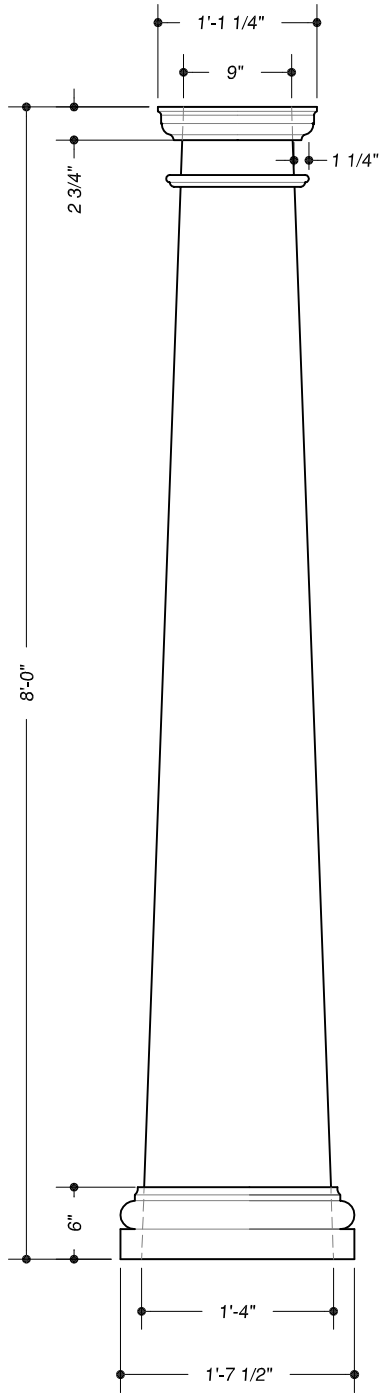

STOCK NUMBER: #46354

QUANTITY: -

PRODUCT MATERIAL: Fiber Reinforced Polymer

OTHER: Includes Tuscan Cap & Base (46353-46356)  
Column Ships Unfinished & Unassembled

Approved by: \_\_\_\_\_

Date: \_\_\_\_\_

Drawn By: CAI, JLC  
Date: -  
Revised: -  
Scale: Not to Scale  
Checked by: -  
Sheet 1 of 1

PermaCast Column  
**Craftsman Column**  
16"x9"x8' w/ Tuscan Cap & Base



1015 Brundidge Blvd.  
P.O. Box 589  
Troy, Alabama 36081  
334.566.5000  
Fax 334.566.4626  
www.hbgcolumns.com

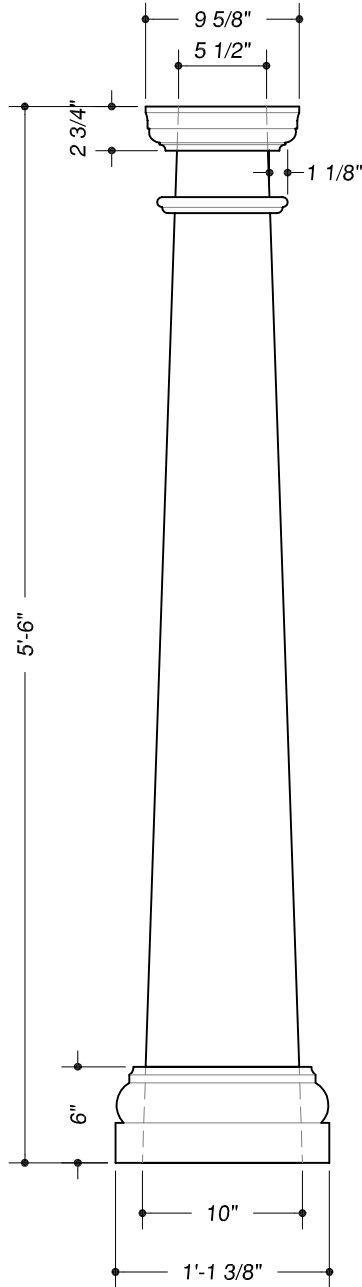

STOCK NUMBER: #46358

QUANTITY: -

PRODUCT MATERIAL: Fiber Reinforced Polymer

OTHER: Includes Tuscan Cap & Base (#46360-46361)  
Column Ships Unfinished & Unassembled

Approved by: \_\_\_\_\_

Date: \_\_\_\_\_

Drawn By: CAI, JLC  
Date: -  
Revised: .  
Scale: Not to Scale  
Checked by: .  
Sheet 1 of 1

PermaCast Column  
**Craftsman Column**  
10"x5.5"x66" w/ Tuscan Cap & Base



1015 Brundidge Blvd.  
P.O. Box 589  
Troy, Alabama 36081  
334.566.5000  
Fax 334.566.4626  
www.hbgcolumns.com

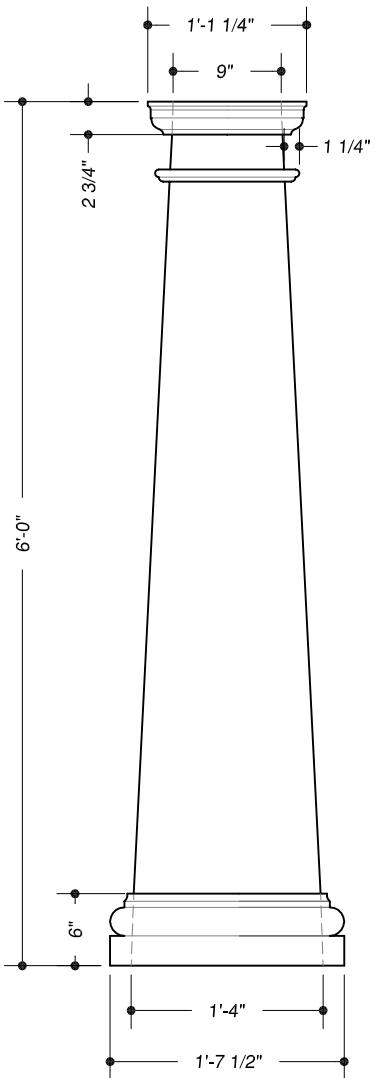

STOCK NUMBER: #46362

QUANTITY: -

PRODUCT MATERIAL: Fiber Reinforced Polymer

OTHER: Includes Tuscan Cap & Base (46355)  
 Column Ships Unfinished & Unassembled

Approved by: \_\_\_\_\_ Date: \_\_\_\_\_

Drawn By: CAI, JLC  
 Date: -  
 Revised: -  
 Scale: Not to Scale  
 Checked by: -  
 Sheet: 1 of 1

PermaCast Column  
**Craftsman Column**  
 16"x9"x6' w/ Tuscan Cap & Base

**H&G**  
 Building Products

1015 Brundidge Blvd.  
 P.O. Box 589  
 Troy, Alabama 36081  
 334.566.5000  
 Fax 334.566.4626  
 www.hbgcolumns.com